

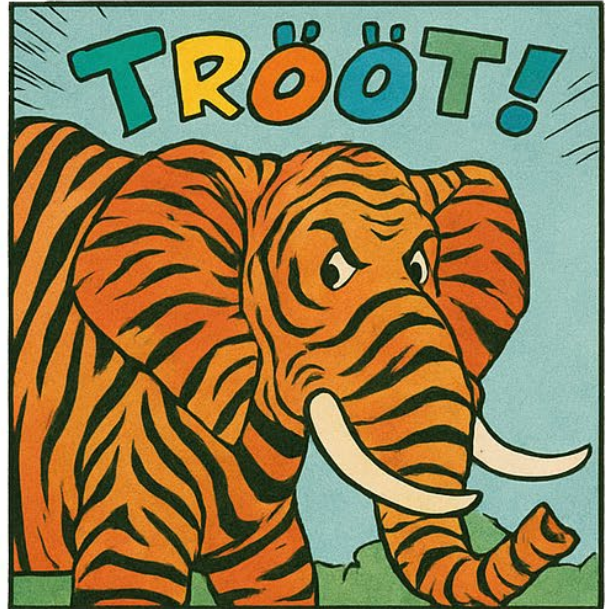

PrivacyPilot



Die Legende des Tigerfantens

Tief im Datenschutz-Dschungel, dort wo Gesetze wie Lianen von Baum zu Baum hängen und wilde Verordnungen in den Schatten lauern, verirren sich viele. Unternehmen stolpern über Abkürzungen wie DSGVO und ISO, stolze Kapitäne ihrer Daten-Schiffe stranden in Paragrafen-Sümpfen, und manch einer verliert im Blättermeer der Formulare den Überblick.

Doch wer genau hinhört, erkennt ein fernes, kräftiges Trompeten und das leise Fauchen eines Tigers. Denn hier lebt er: der Tigerfant.

Der Tigerfant ist kein gewöhnliches Tier. Mit der Weisheit des Elefanten kennt er jeden Pfad, jede verborgene Vorschrift und jede Abkürzung, die sicher ans Ziel führt. Mit der Stärke des Tigers springt er über Stolperfallen, schlägt sich durch Paragrafen-Gestrüpp und verjagt die hungrigen Datenkraken, die gierig nach ungeschützten Informationen schnappen.

Er führt tapfer durch die Wirren des Datenschutz-Dschungels. Seine Streifen sind Zeichen seiner Erfahrung – jede Linie erzählt von einer Schlacht gegen Chaos, Missverständnisse oder vergessene Löschrufen. Und wer ihm folgt, findet am Ende des Weges Klarheit, Sicherheit und Ruhe.

Darum haben wir den Tigerfant als kleinen Klemmbaustein-Begleiter erschaffen. Er erinnert dich stets daran: Auch wenn der Dschungel dicht ist und die Regeln streng – mit Mut, Verstand und der richtigen Hilfe findet man immer den Weg hinaus.

Folge dem Tigerfantem.

Er kennt den Weg.

Er ist der

PrivacyPilot



Der PrivacyPilot bietet eine praxisgerechte und effektive Lösung zur Einhaltung der gesetzlichen und aufsichtsbehördlichen Datenschutzanforderungen einschließlich des SDM 3.1a und IT-Grundschutz-Kompendiums des BSI. Durch seine einzigartige Methodik können Geschäftsprozesse detailgenau und valide beschrieben werden. Dieser belastbare und umfassende digitale Sachverhalt ist die Grundlage für die Vielzahl wertschöpfender Funktionen des Systems.

Methodik

Der PrivacyPilot ermöglicht eine detaillierte Beschreibung von Verarbeitungstätigkeiten unter Verwendung LegalTech-fähiger, strukturierter Daten. Der damit einhergehenden Komplexität begegnet das System durch eine leistungsstarke Methodik. Auch eine Vielzahl von Verarbeitungstätigkeiten kann mit wenigen Klicks über die Verwendung von Filterfunktionen unter Zuhilfenahme von Mustervorlagen und intuitiver Massenbearbeitungsfunktionen strukturiert bearbeitet werden. Daneben kann das gesamte TOM-

Konzept detailgenau erfasst und mit den relevanten Verarbeitungstätigkeiten verknüpft werden. Optional gelangt der Nutzer über eine risikobasierte Analyse des Sollzustandes in „Risiko-Mastern“ zu einer teilautomatisierten Datenschutz-Folgenabschätzung.

Leistungsumfang

- Master-Methodik (VT, Risiko, TOM, AV) unter Verwendung strukturierter Daten
- KI-Chatbot (optional)
- Indikatoren für aussagekräftige KPI
- SDM 3.1a
- BSI-Grundschutz
- Aufgabenmanagement
- Teilautomatisierte DSFA
- Regelengine
- LegalTech
- Adaptives Reporting
- Marktplatz zum Kopieren oder Abonnieren von Mustervorlagen
- Einhaltung der KI-VO

**Mit dem PrivacyPilot
aus dem Datenschutz-Dschungel**





Strukturierte
Daten



LegalTech



Belastbares
VVT



Teilautomatisierte
DSFA



SDM 3.1



IT Grundschutz
Kompendium



KI-VO



ISO 27001



Marktplatz



Aufgaben-
management



Indikatorbezogene
Nutzersteuerung



KI
Integration



Umfangreiches
Reporting



Maximale
Flexibilität



Weitere
Rechtsgebiete



Betroffenen-
anfragen

Sie haben Interesse an einer Produktvorführung
oder wollen mehr über den PrivacyPilot erfahren?

Schreiben Sie uns



www.privacy-pilot.com

Aufbauanleitung

**Mit dem PrivacyPilot
aus dem Datenschutz-Dschungel**



1

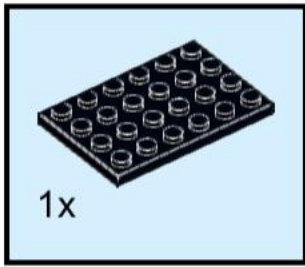

2

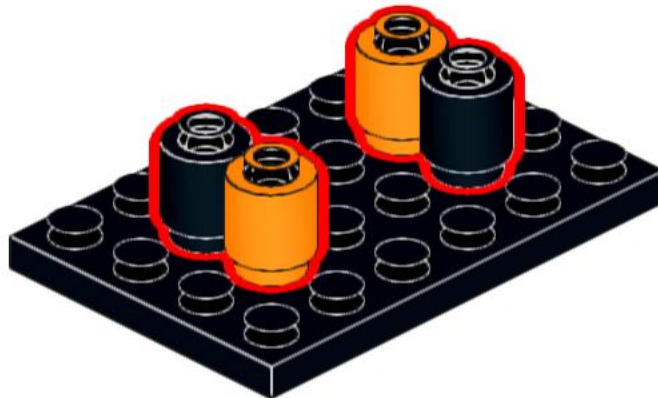
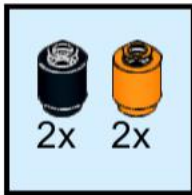

3

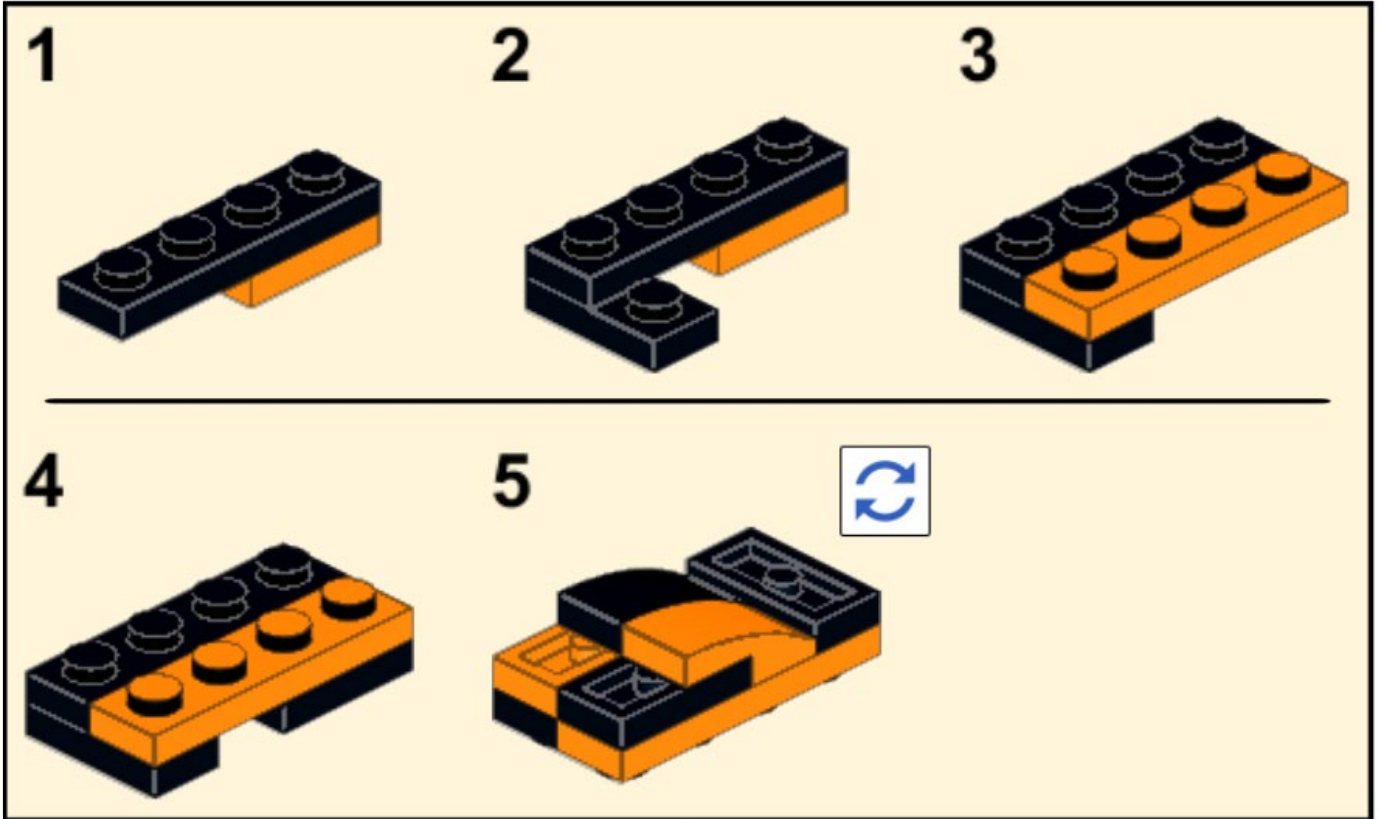
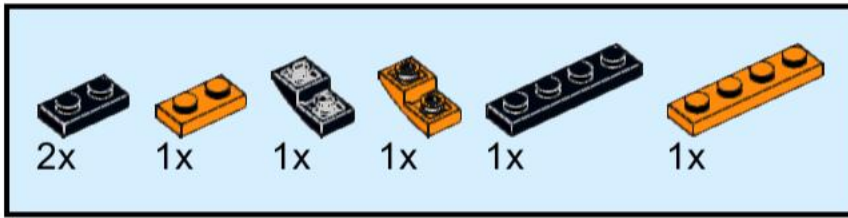

4

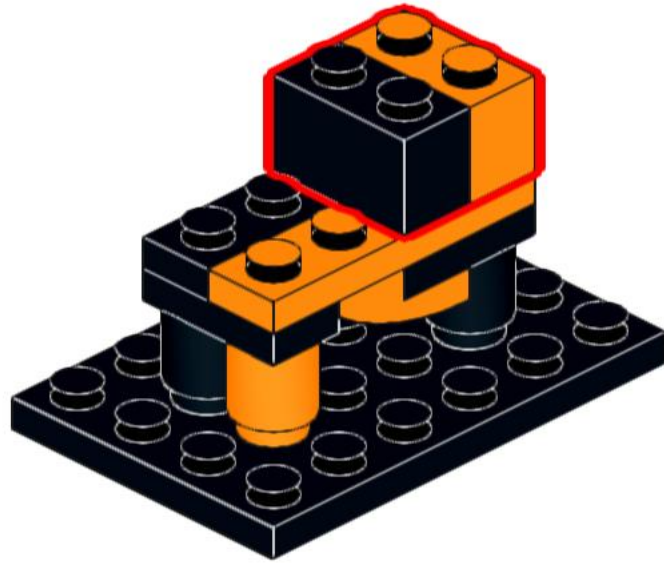
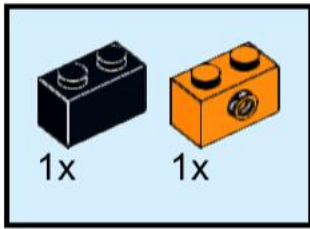

5

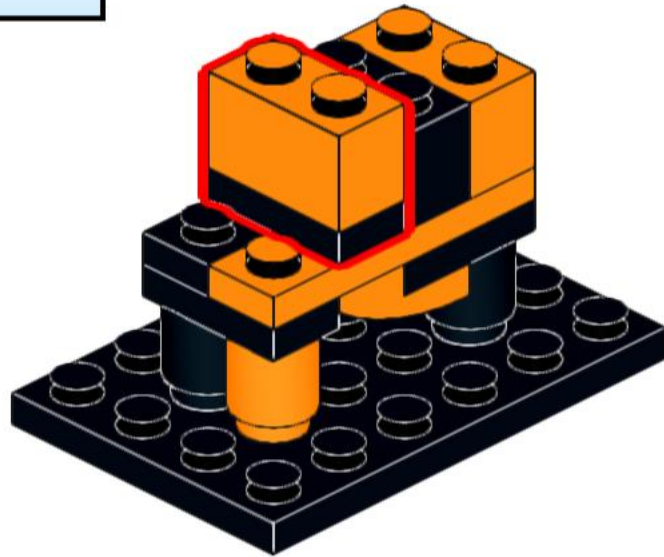
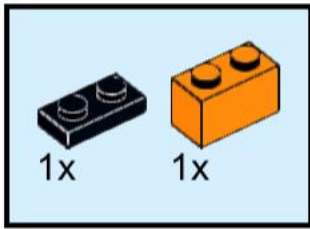

6

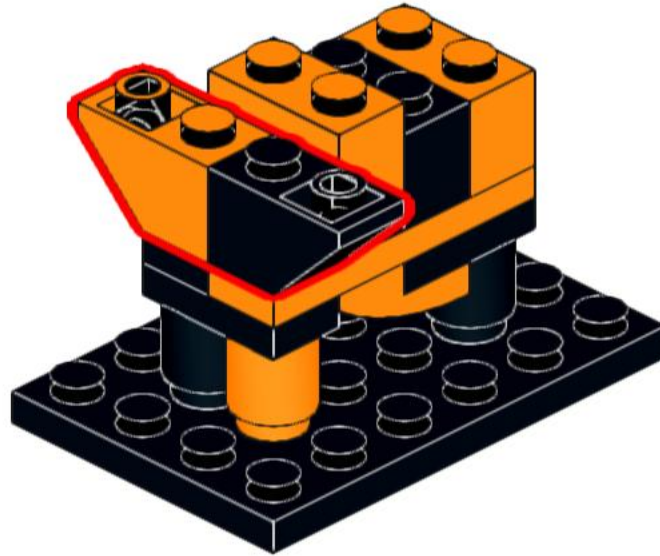
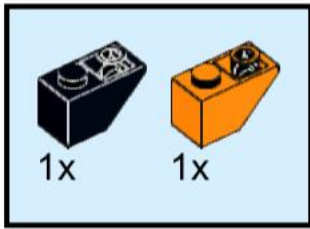

7

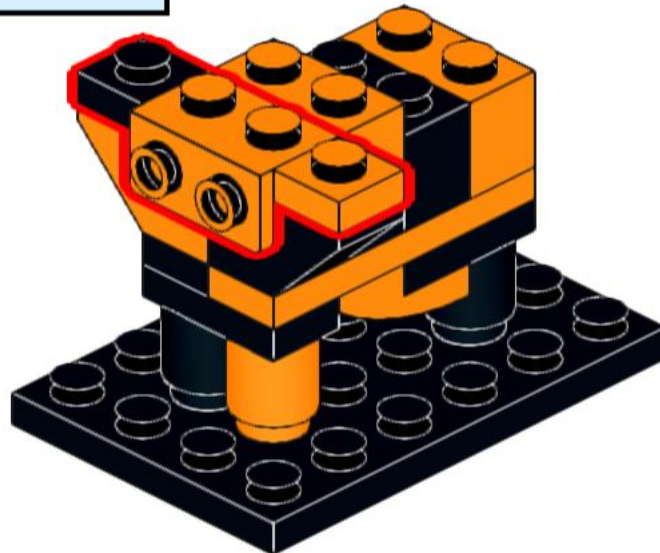
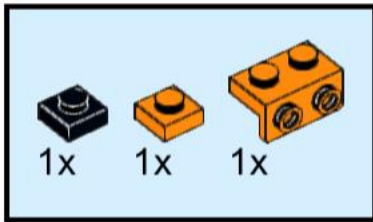

8

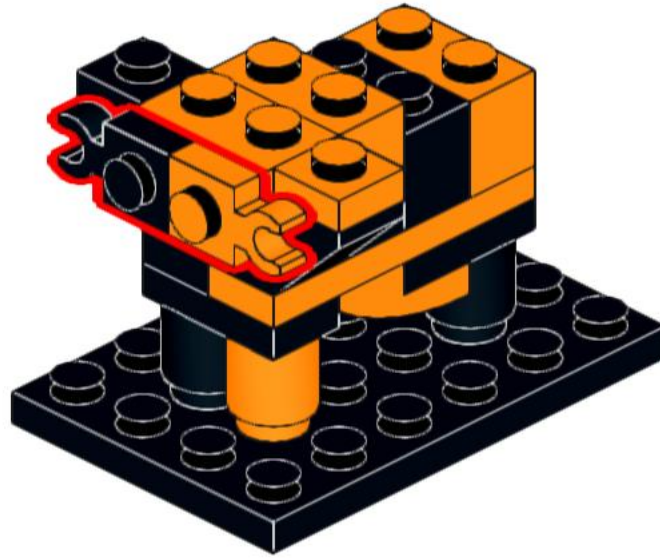
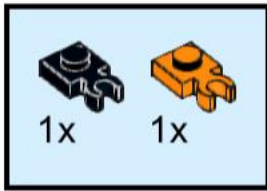

9

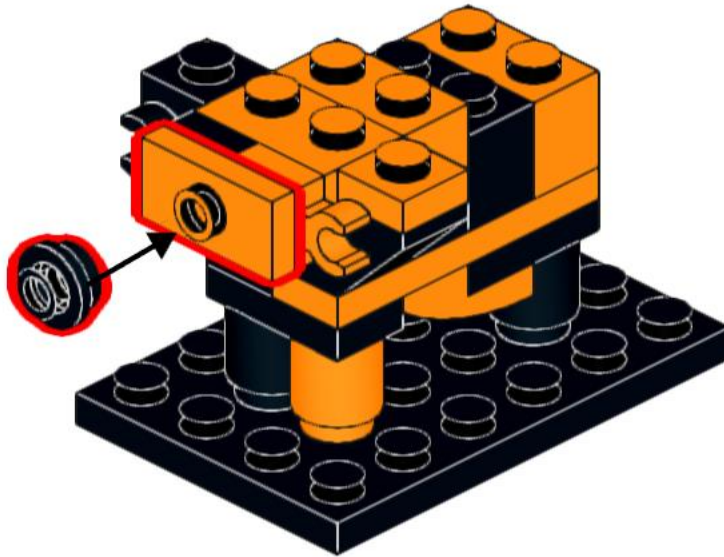
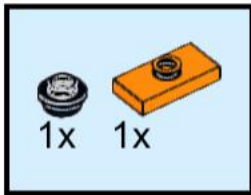

10

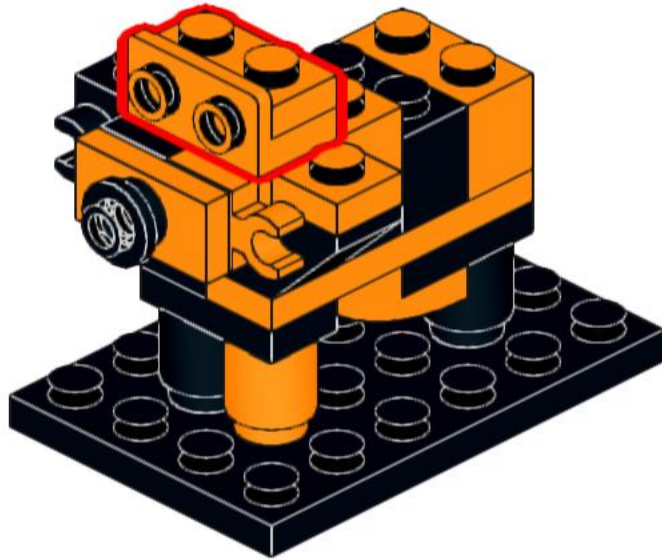
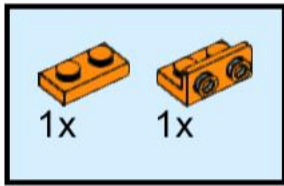

11

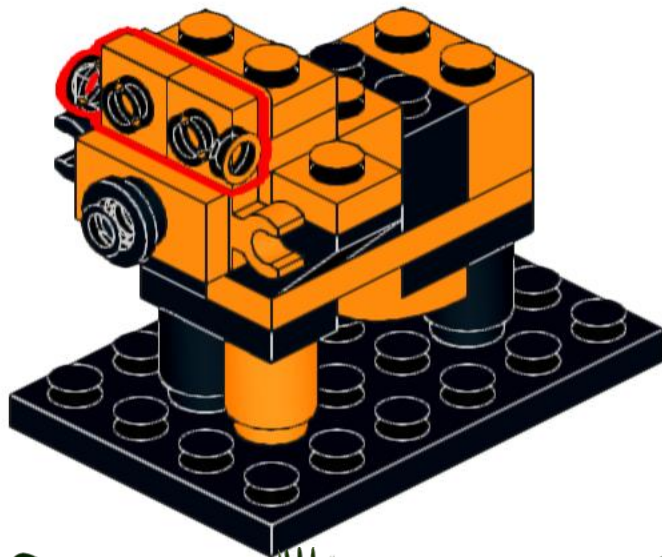

PrivacyPilot

www.privacy-pilot.com

12

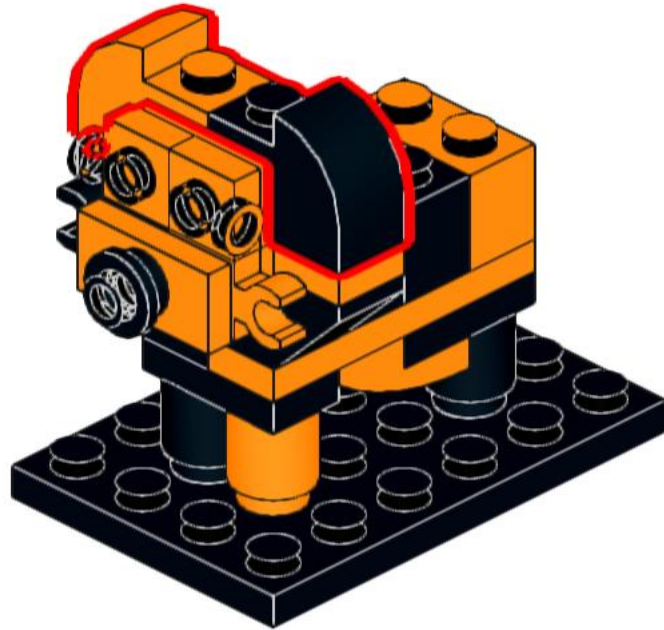
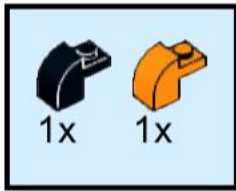

13

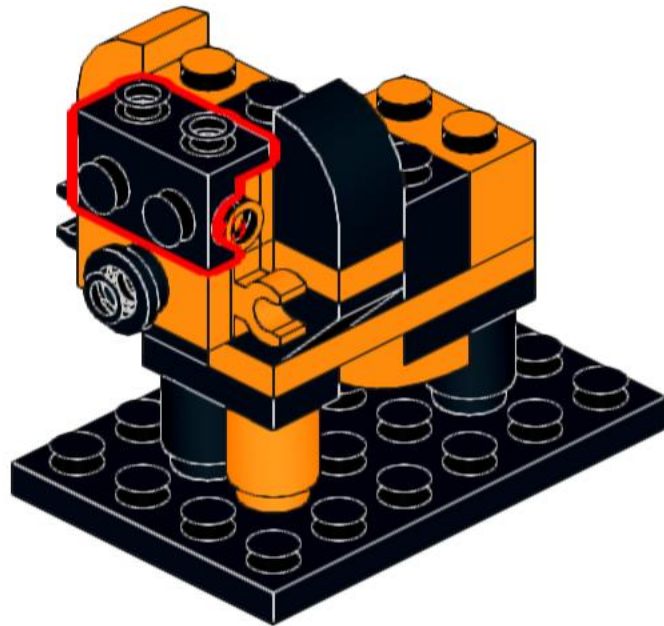
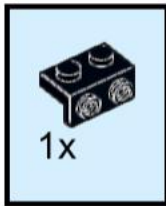

14

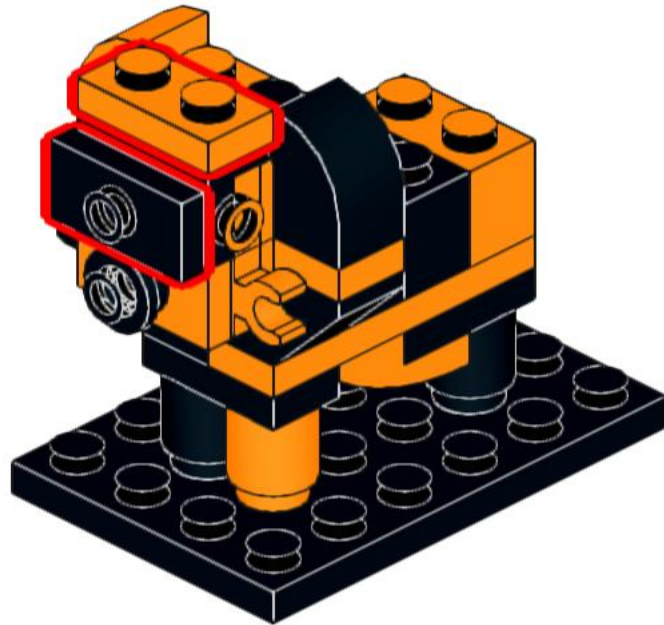
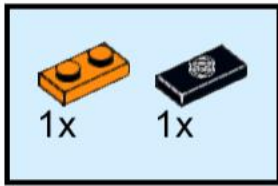

15

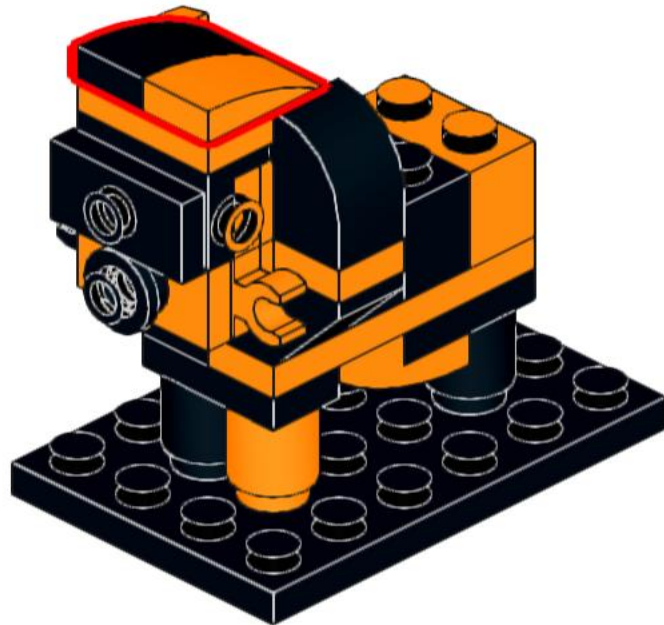
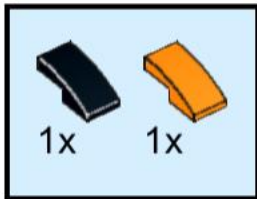

16

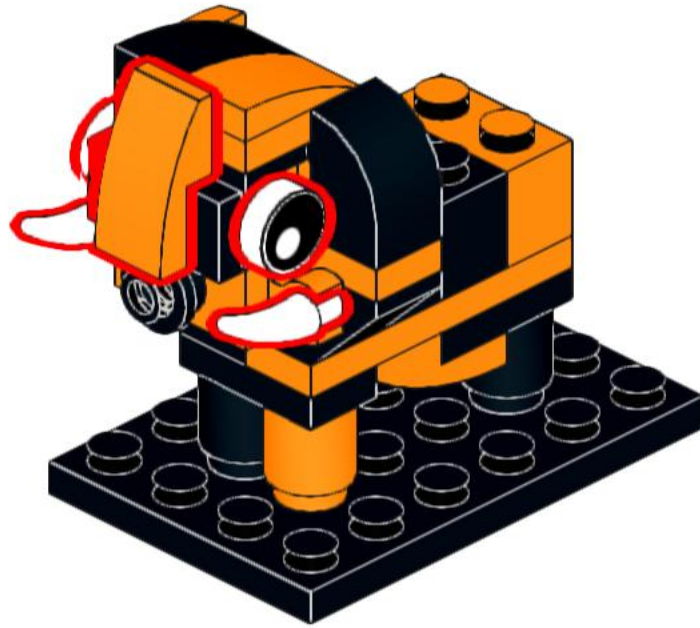
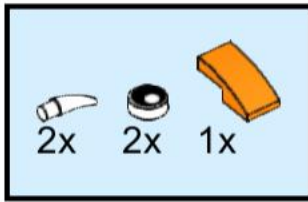

17

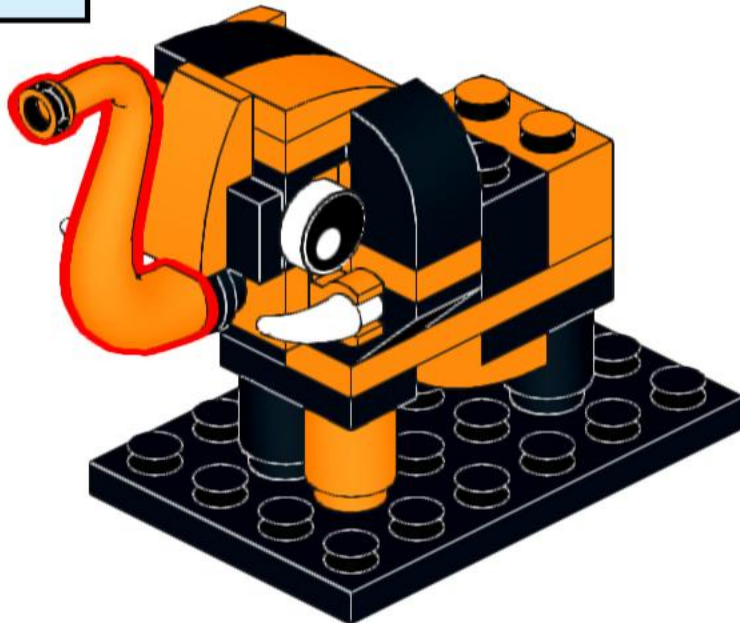
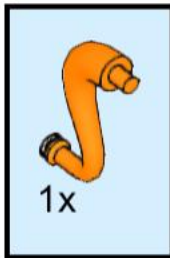

18

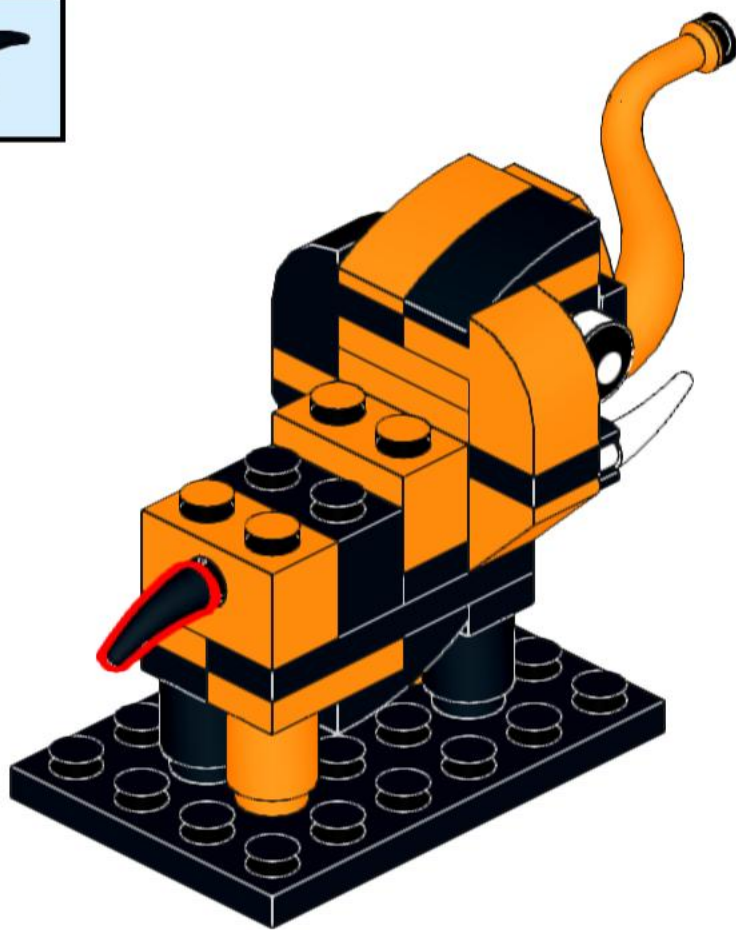

19

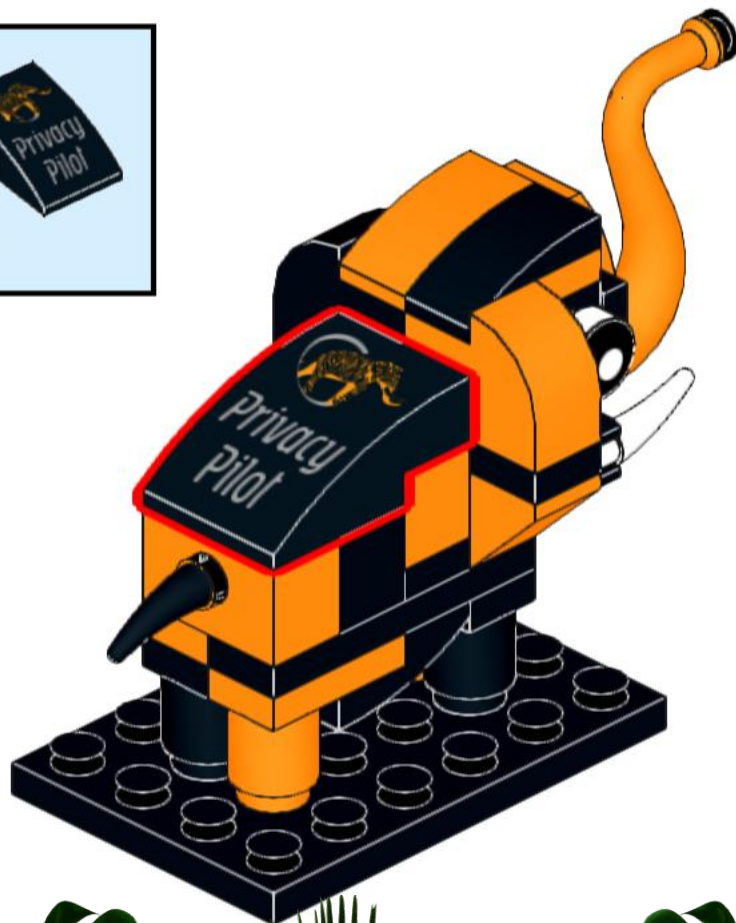

PrivacyPilot

www.privacy-pilot.com

20

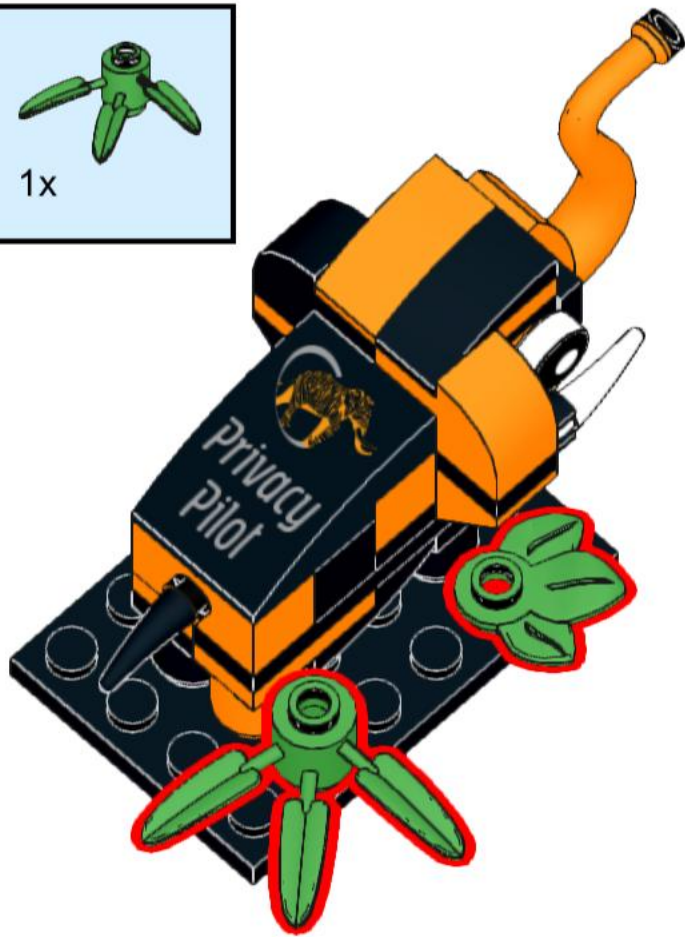
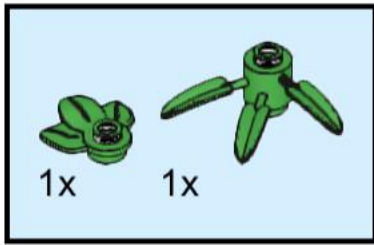

21

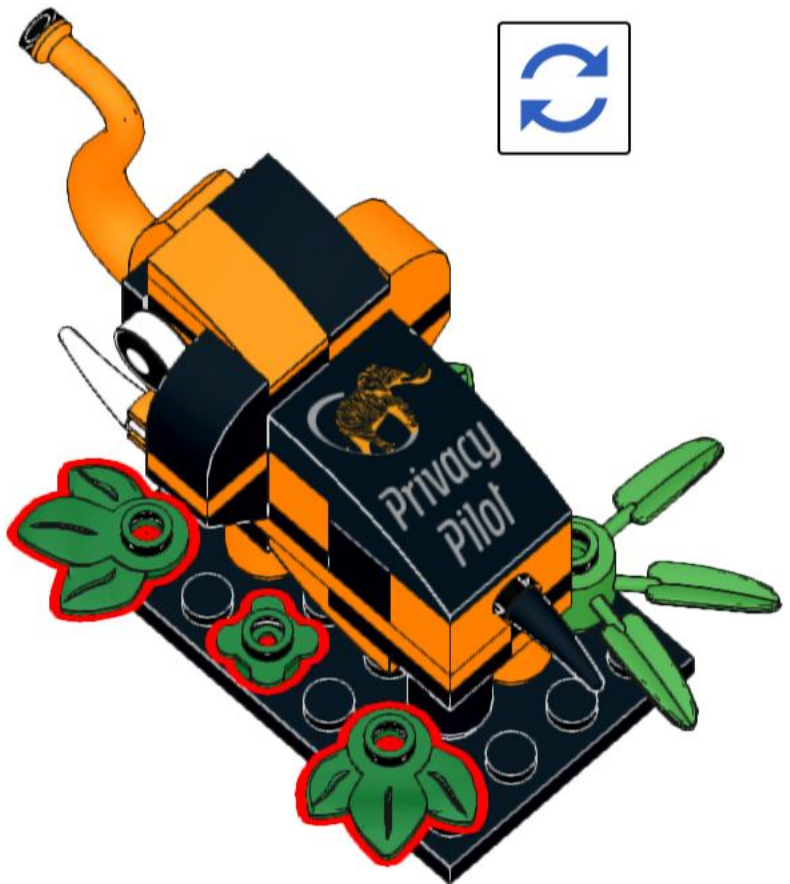
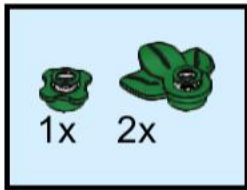

PrivacyPilot

www.privacy-pilot.com

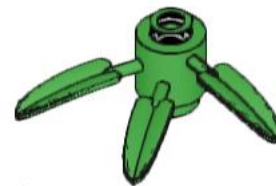
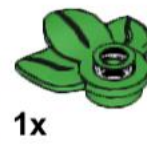
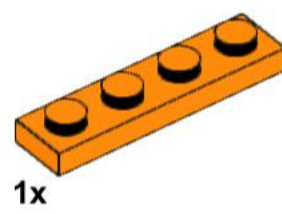
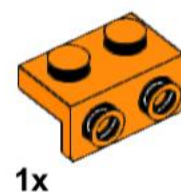
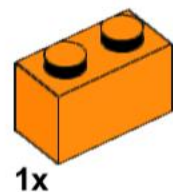
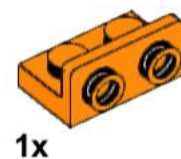
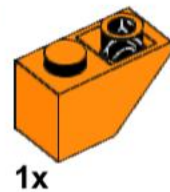
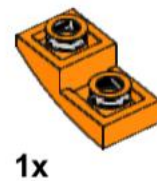
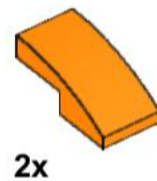
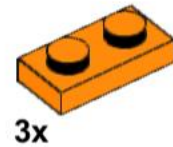
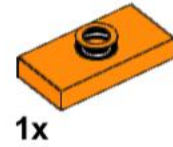
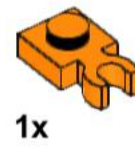
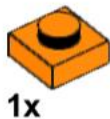
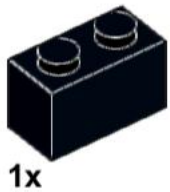
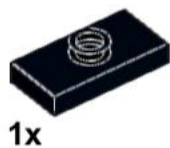
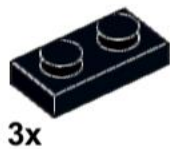
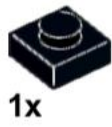
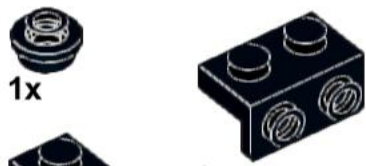



Achtung! Nicht geeignet für
Kinder unter 6 Jahren.
Erstickengefahr durch
verschluckbare Kleinteile.

PrivacyPilot GmbH

Adenauerallee 136
D-53113 Bonn

Tel.: +49 (0) 228-504 46 270
Fax: +49 (0) 228-504 46 249

E-Mail: info@privacy-pilot.com
Internet: www.privacy-pilot.com

Handelsregister: HRB 28627
Registergericht: Amtsgericht Bonn

Geschäftsführung (einzelvertretungsberechtigt):
Stefan Kleinert



PrivacyPilot

www.privacy-pilot.com